

Washing systems

Serving the global pharma industry



Steelco GROUP



“For the Environmentally conscious”



Solutions for the pharmaceuticals and biotechnology companies

Located in modern factories near Venice in Italy, **Steelco Group** is a major global supplier of infection control and contamination prevention for the healthcare, laboratory and pharmaceutical sectors. Steelco's success is demonstrated by its strong growth, becoming the partner of choice for many of the world's leading pharmaceutical companies who appreciate the company's:

Extensive product range

With over 3000 installations worldwide, Steelco offers a wide portfolio including:

- Innovative washing equipment, customizing loading racks to customer needs.
- Diversified, steam and ETO sterilization range.
- Innovative fully automated closure processing equipment.
- Drying and depyrogenation ovens
- Automation systems to maximize productivity and safety.

Flexible solutions

- Ability to meet the most challenging processing needs.
- Only using best proven readily available control systems and components.

Experience and knowledge

- Strong track record of establishing long term global partnerships.
- Integrated in-house operations from incoming raw materials to installation, validation and technical support.
- Fully certified quality systems with knowledge of pharmaceutical manufacturing standards.

Global footprint

- Global HQ in Italy with regional customer support centres in America and Asia.
- Network of factory trained agencies in over 100 countries worldwide.



Center of washing systems production



Center of sterilizers production

Steelco Headquarters



Quality engineering process

Steelco Group’s engineering experience encompasses knowledge and understanding to be able to satisfy the most stringent requests from clients.

Technical consulting, design, engineering, project management, as well as commissioning and qualification services of our equipment is offered, with customers appreciating the cost effective high performance solutions offered to resolve complex washing and sterilization challenges.

Our respected engineering experience in the medical, laboratory, pharmaceutical and biotech fields allows us to develop a proven approach that prioritizes the pharma manufacturing process and safety bearing in mind life cycle costs of the equipment.

Our methodical approach is to first develop an in-depth understanding of the project and the product goals in order to offer the best equipment and solution for the application.

Customers are always welcome to visit Steelco factories to see design and manufacturing methods and audit our processes.



Quality system certification

In addition to having a certified Quality System as per ISO 9001 (and ISO 13485 for Medical Division), our products are subject to rigorous quality control systems and inspection. This coupled with continuously training our technically specialized personnel ensures you receive best in class product solutions and support.

We constantly strive to improve on our high standards to enable us to deliver optimal solutions for our partners in the pharma industry.



ISO 9001:2008
Quality management systems



ISO 13485:2012



AEO/C Certification



SAI GLOBAL
ISO 13485:2003
& CMDCAS
CERT-0069883



3D project layouts

Steelco Group offers complete “turnkey” solutions for washing and sterilization processes in the pharmaceutical sector, with the ability to undertake all stages of a project from concept to delivering solutions that exceed customer expectations.

Steelco’s extensive experience assists customers to increase process productivity and quality with improved ergonomics whilst limiting costs.

Steelco Group: Leading the Way with a Risk Based Approach to Data Integrity

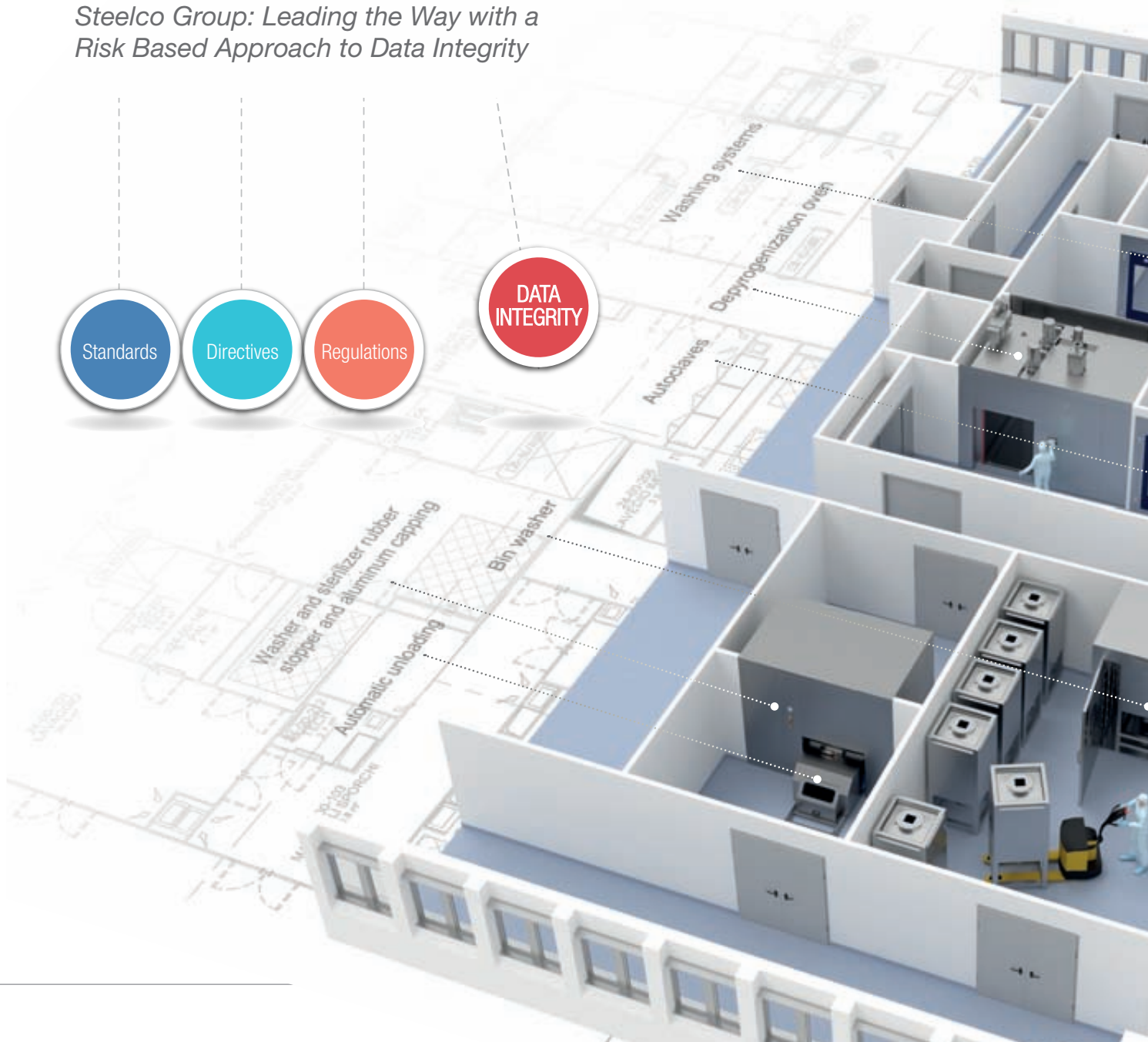



Extensive customer support services

Steelco Group offers a comprehensive range of services to ensure the success of projects at each important step including:

- Process and workflow design
- Process equipment design and manufacture
- Automation and SCADA
- Installation and commissioning
- Training packages, from basic to in-depth
- Validation and documentation:
- cGMP compliance consultancy and assessment
- Training and assistance if requested by pharmaceutical companies as well as regulatory inspectors on GMP related topics
- Spare parts supply and first line service training
- Fully comprehensive and preventative maintenance contracts
- Periodic validation and re-qualification as required.

For all previously installed equipment Steelco can offer a range of customizable service packages. Customer service excellence is Steelco Group's commitment to our clients and a cornerstone of our success with emergency service support if needed available, 24 hours, 7 days a week.



Academy

Subject matter expertise is shared by our trainers at the Steelco academy near Venice, Italy or at locations convenient to customers, with training on a wide range of topics that are focused on:

- Standards and work practices
- Equipment and its use
- Technical service training



Design warranty

Thanks to the design and quality of equipment, as well as the reliability of the components used, Steelco can offer extended warranties.

Performance and guarantee on Steelco equipment is according to the technical characteristics stated in the offer.

Only the best available “*Non-Proprietary*” components such as valves are sourced. Components are selected for their reliability and availability to reduce running costs and down time.

Steelco can use customer preferred parts provided that these meet performance and reliability requirements.





Control system

User friendly control systems developed according to the latest GAMP and design for 21 CFR Part 11 available, sourced from the best available suppliers avoiding customized electronics.

Steelco Group can provide software source codes, allowing its customers to become **owners of the control system** of the machine (“open source architecture”).

System platforms available include Siemens and Allen-Bradley which are easily integrated with those already installed by pharmaceutical companies. The software is structured and commented in English to allow a better understanding of functionality. **Multi Language tool** for development software is also available.

Software is developed in compliance with current coding rules and programming and according to standard ISA 88, ISA 95, IEC 61131-3 standard & GAMP 5.

The structure is designed for straightforward validation by the end user.

Tools to simplify validation are also available (validation wizard).

Remote diagnostic capabilities are available for all our controller solutions.

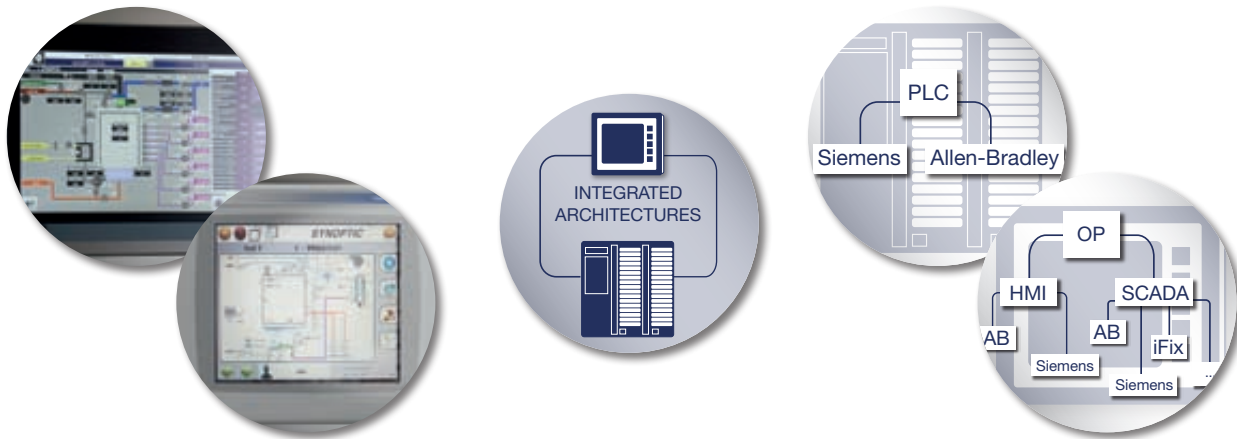

International standards:

ISA 88	Standard addressing batch process control
ISA 95	Enterprise-Control System Integration
IEC 61131	Programmable controllers

Integrated architecture

Steelco can install new equipment into an existing automation system through the adoption of a simple (HMI) or more sophisticated (SCADA) man-machine interface.

Complete customization of access levels is available (local or domain users).

In compliance with the individual internal policies of each customer, Steelco Group offers remote service access by using virtual private networks to ensure the confidentiality and safety of all transferred data.

Safe remote access using UMTS/LTE/GPRS networks solutions are also available.

All Steelco machines share the same interface system: despite different functions of models with a logical evolution based graphic interface to ensure easier training and use by operators.

Our machines are level 1 and 2 of the standard ISA 95, with the ability to connect and supply all the next levels.

Level 4	BUSINESS LOGISTIC SYSTEMS (ERP)	BUSINESS PLANNING & LOGISTICS Plant Production Scheduling, Operational Management, etc	Establishing the basic plant schedule - production, material use, delivery, and shipping. Determining inventory levels. Time Frame: Months, weeks, days
Level 3	MANUFACTURING OPERATIONS SYSTEMS MES, BATCH, LIMS, AM, etc	MANUFACTURING OPERATIONS MANAGEMENT Dispatching Production, Detailed Production Scheduling, Reliability Assurance...	Work flow / recipe control to produce the desired end products, maintaining records and optimizing the production process. Time Frame: Days, Shifts, hours, minutes, seconds
Level 2	CONTROL SYSTEMS PLC, DCS, PAC	MANUFACTURING CONTROL Basic control, supervisory control, process sensing, process manipulation	Monitoring, supervisory control and automated control of the production process. Time Frame: Minutes, seconds
Level 1	INTELLIGENT DEVICES FLOW, VISION, PRESSURE, etc		Sensing the production process, manipulating the production process. Time Frame: Minutes, seconds, milliseconds
Level 0			The actual production process. Time Frame: Minutes, seconds, milliseconds



Validation documents

User safety, product quality and data integrity are Steelco Group core values.

Equipment is developed and validated according to the latest GAMP and cGMP standards. Steelco “know-how” allows the client’s to benefit from optimal solutions for their individual requirements, in order to perform effectively and reproducibility cleaning, sterilization and validation of pharma production components.

A risk based approach to comply with regulatory requirements is fundamental in the development of our validation documentation. An extensive package is available to minimize on-site validation time.

Steelco Group documents include but are not limited to the following:

- Hardware Design Specification
- Functional Design Specification
- Software Design Specification
- P&ID (Piping and Instrumentation Diagram)
- Component List
- General Arrangement Drawing
- Electrical Drawings
- Quality and Project Plan
- Traceability Matrix



Steelco Group is available to customize documentation packages according to customer standard requirements and to produce specific documents upon request.

Pre-validation of Steelco Group equipment ensures minimal project risk, less time and cost to qualify the units on site.

Acceptance Tests & on site activities

Factory Acceptance Test and Site Acceptance Tests.

Steelco Group is available anytime to support customers during all acceptance on site including process development and mapping.

All on site activities undertaken to pre-agreed written to pre-agreed protocols according to GDP and HSE requirements.

Steelco keeps records of the technical file of each machine to enable full access in case of third party inspection to verify compliance with directives and regulations currently in force.

Expertise in Design Quality and Hazop is available to customers.

Installation qualification (IQ), operational qualification (OQ), and performance qualification (PQ) are provided in standard version or customized according to the final scope of supply.

Our equipment manufacturing centres are equipped with water production systems that can simulate water quality found at customer sites.



Spray coverage test: riboflavin contamination of critic areas before cleaning phase.

V-MODEL FOR SPECIFICATION, INSTALLATION, START UP AND QUALIFICATIONS

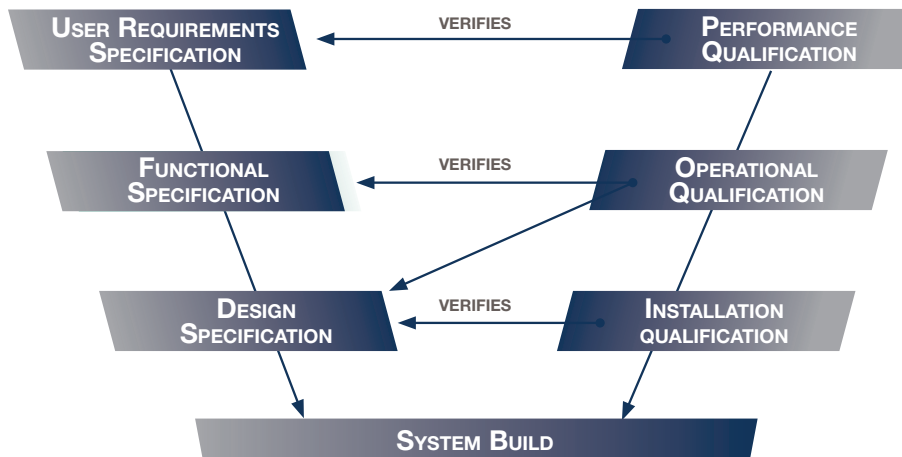



Compliance and guidelines

The design and the production of our washing and drying systems is based on standards and guidelines recognized both worldwide as well as in the final installation country:

Guidelines:

- European cGMPs
- US FDA CRF
- 21CFR part 11
- cGLP
- UNI-INAIL (similar to OSHA standards)
- ASME
- ANNEX 15
- ICH Q9: Quality risk Management (European guideline)
- ISPE baseline

Standards

- Directive 2006/42/EC
- Directive 2014/30/EU
- IEC 61010
- EN ISO 12100
- EN 61326-1
- EN 13849-1
- EN ISO 14159
- ASTM A380
- ASTM A967
- UL Standards

Think globally

Tailoring your future

www.steelcospa.com

www.icospharma.com

Steelco Group subsidiaries and agents provide technical expertise and support in over 100 countries worldwide



cGMP WASHING SYSTEMS

Unparalleled high performance range





Steelco DS Series Pharma Grade Washers

Exceed industry standards

Pharmaceutical grade machines are available as **single door or pass-through double door versions** to provide an effective barrier system between different zones. All machines feature large glass sliding doors to reduce size and assure easily and safety access.

Steelco standard pharma machines range from 0.23 to 2,4 m³ volumes capacity for standard washing requirements with customers additionally having the option of specifying customized chamber dimensions to meet their individual needs.

Using their extensive experience and sophisticated computer modelling Steelco's engineering department optimizes cart design in order to reduce process time and water consumption whilst maximizing process effectiveness.

Field of application

Counting some the largest Pharma companies as its customers, Steelco has an in-depth understanding of the particular critical cleaning, disinfection and drying requirements of equipment and components used in pharmaceutical production including:

- Glassware
- Filling line components and tools
- Tubing, TC fittings
- Valve and pump bodies, filter housings
- Punches and Dies
- Reactor vessels and diverse equipment
- Bulk containers, tanks and carboys

Complete layout versatility

Washing/Drying machines available as single door or pass-through double version, with automatic motorized opening in vertical (either up or downward) or horizontal sliding doors. Also available in hinged door version.



DS 4000 PH

DS 3000 PH

Chamber volume

**from 230 litres / 8 cu.ft
to 2.400 litres / 85 cu.ft**

in several different dimensions with configurable options

Technical data, utilities consumption and drawings available upon request.

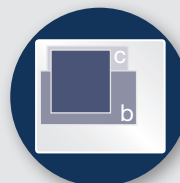

chamber shape



horizontal sliding door

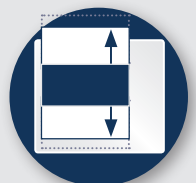

vertical sliding door



DS 2500 PH

DS 2000 PH

DS 1500 PH

DS 1000 PH

DS 800 PH

- ✓ Highest cleaning performance
- ✓ Protection of processed items
- ✓ Low power and consumption
- ✓ Drying efficiency system
- ✓ Repeatability and validatable process
- ✓ Globally available components and technical support

Interfacing with isolator



right or left technical area



hinged door

Safety and ergonomics are our priority. Possibility of interfacing unloading door with various models of isolators.





Steelco DS PH range

Technical features

The washing chamber and the hydraulic system are designed and constructed with extreme care and finished to $Ra < 0.5\mu m / 19,7\mu m$ smoothness, of crevice-free construction, with orbital welding for piping in order to eliminate water retention and stagnation points where bioburden could form.

AISI 316L stainless steel is used internally throughout with EPDM, PTFE or other FDA approved gaskets (21CFR part 177).

All models feature angled surfaces and rounded corners to ensure complete drainage.



Special applications

Steelco can provide customised solutions with special drying programs or HPV (hydrogen peroxide vapor) decontamination according to customer needs.



Pull out electrical panel configured to different global electrical standards



Water treatment supply



Combination of clamps and welded construction

Extensive documentation is provided on the orbital welding



Washing chamber and sump

All the connections to the washing chamber respect the L/D <3 formula to ensure the cleaning integrity of all surfaces.



Smooth and completely drainable surfaces.



Detergent valves

Detergent inlet valves with zero dead legs.



Exhaust valve

With partial closure to reduce energy loss. With hermetic closure in case of washing toxic substances.



Washing pump

Stainless steel high quality washing pump with drain valve.



Drying and filtering

The heating elements enable variable drying temperature control. The HEPA filter is placed in line at the end of the drying path before entering the chamber and rack.



Drain valves

Double drain system with single or double total closure with no residual water left.



Chemical dosing system



Alcove for sampling system



Total Organic Carbon

TOC analysis provides cleaning validation and detects organic contaminants in process water.



Pharma carts and trolleys

Standard and customized solutions

Steelco's engineers experience and sophisticated 3D CAD programs ensures that every point, corner and cavity of an item to be processed is deeply and accurately washed.

This avoids the possibility of cross-contamination and eliminates all soil and contaminant residues from the previous use.

The same injection porting is used to also convey hot sterile filtered air inside each cavity for drying.

- ✓ *Optimized load configuration*
- ✓ *Process effectiveness*
- ✓ *Reduction of cycle time*

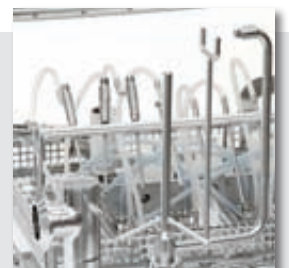
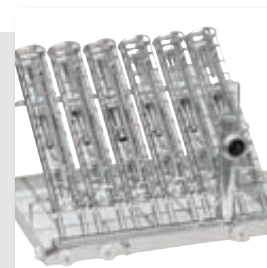

*Height adjustable transport trolley:
flexibility and safety*

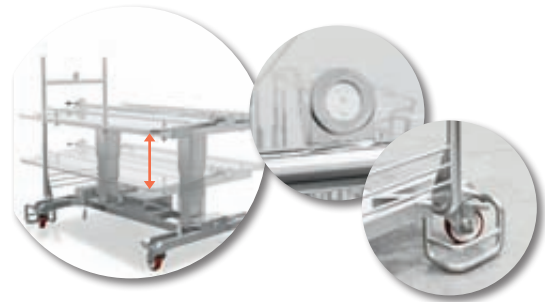

*Injection wash carts
for any applications*

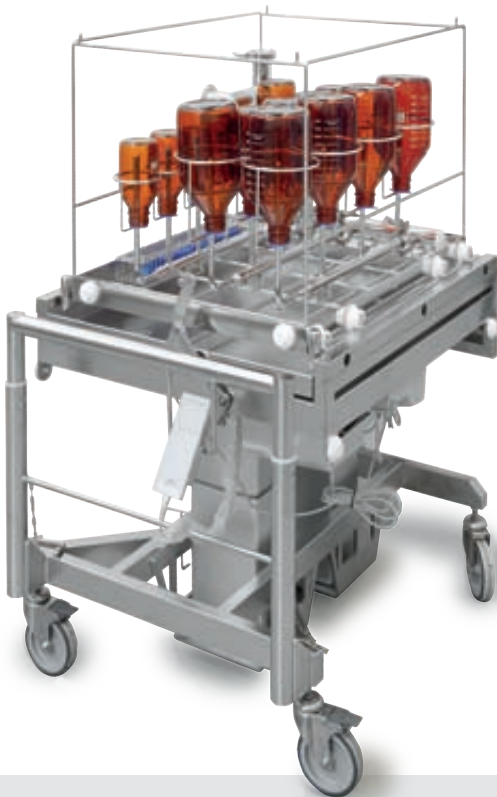
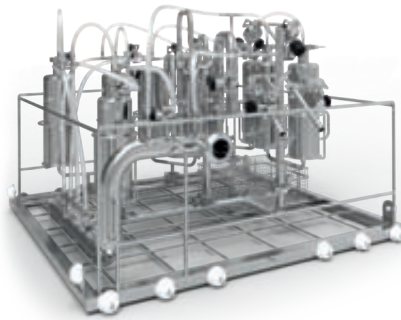

Customized rack configurations

Steelco has developed a global reputation for being able to respond to the most challenging customer requests.

Steelco designs, develops, manufactures and tests all its own wash cart racks in-house, ensuring that the quality of this critical process is carefully monitored.



Steelco ML PH Series Pharma Grade Parts and Glassware Washers

This machine offers pre-washing, washing, rinsing, drying and cooling phases with optimal performance in a compact size and footprint solution.

Hinged type chamber doors with single or double door and double locking device made in accordance with requirements for clean environments.

Use of FDA approved components (valves, filters, piping, tri-clamp fittings, pumps, etc.). Drying by HEPA filtered hot air at max. 130°C.

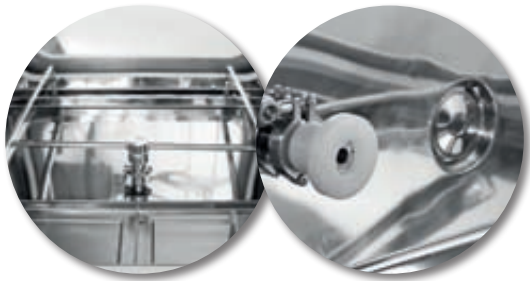

Field of application

Machines are designed for pharmaceutical products such as **glassware, pipettes, machine parts, tanks, glass bottles, pill stamps, carboys, tubes, needles**, etc.

Construction features

- ✓ Low running and life cycle costs.
- ✓ Use of 316L stainless steel with roughness less than 0.5 μm (20 micro inches) on all components in process contact (machine body, machine doors, spray nozzles bars, process piping, instruments, valves, racks, internal carts, baskets, etc.).
- ✓ Orbital welding on all piping with tri-clamp fittings.
- ✓ Respecting 3-D dead legs with the application of Zero-Static (0-Dead legs) components.
- ✓ All internal corners of the chamber have radiuses as per cGMP requirement.



Chamber volume

**from 465 litres / 16 cu.ft
to 3800 litres / 134 cu.ft**

in several different dimensions with
configurable options

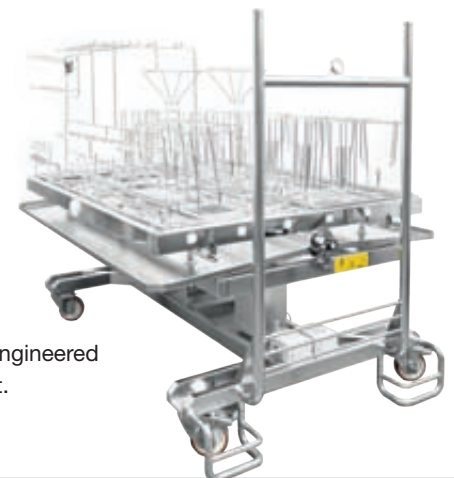

Customized and engineered
loading equipment.



See

CABINET WASHING SYSTEMS

For the perfect cleaning
of large items



Steelco LC PH Series Cabinet washing system



Chamber volume

**from 4.250 litres / 150 cu.ft
to 10.500 litres / 371 cu.ft**

in several different dimensions
with configurable options

With a full range of washing carts dedicated to:

- Glassware
- Filling line components and tools
- Tubing, TC fittings
- Valve and pump bodies, filter housings
- Punches and Dies
- Reactor vessels and diverse equipment
- Bulk containers, tanks and carboys



“Large object washed to pharmaceutical standard”

Advantages features

The Steelco LC PH range is a versatile system to wash containers, large components, ultracentrifuges, bulk chemicals: developed for all applications where it is necessary to treat large volume of items or large diameter components.

The machine base, manufactured with easy removable continuous modules, allows the operator to walk with safety on it. The lateral rotating washing tubes achieve perfect washing results.

High performance efficiency with steam heater versions available.

- ✓ *Highest cleaning performance*
- ✓ *Easy cart connections*
- ✓ *Double drying unit with capacity of 1000 m³/hour*
- ✓ *Lateral rotating washing pipes with nozzles to assure a adequate cleaning of all parts of loaded items.*
- ✓ *Repeatable and validatable*

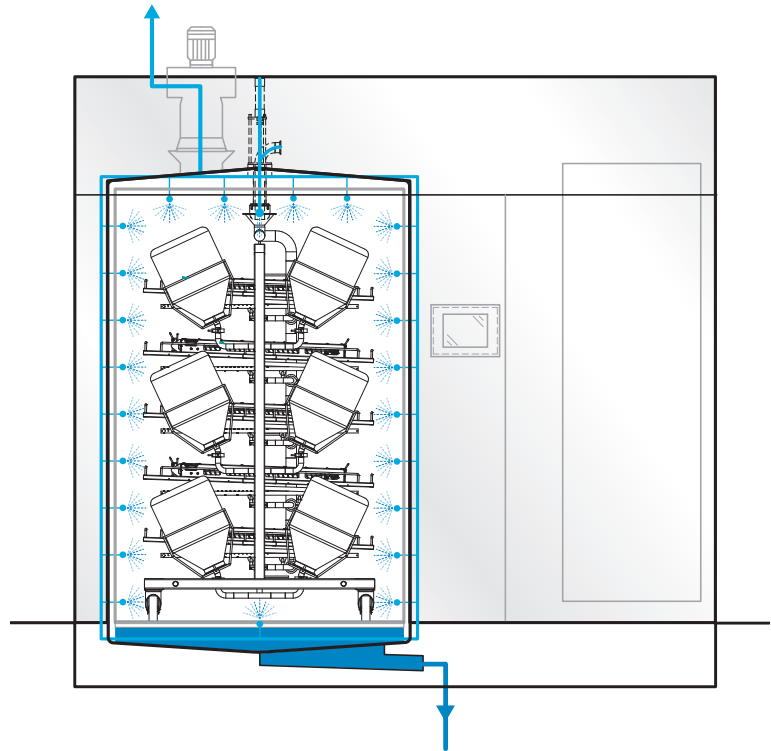

From concept to execution

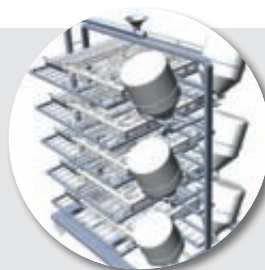
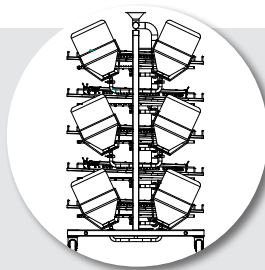



Steelco LC PH Series Washers technical features

The washing chamber and water circuits are designed and constructed with extreme care, finishing with a minimum smoothness of $Ra < 0.5\mu m / 19.7\mu in$, with crevice-free construction of chamber, piping and racks in order to eliminate water retention and stagnation points where biofilm or corrosion could form.

Washing chamber manufactured in AISI 316L stainless steel and external body in AISI 304 stainless steel. AISI 316L stainless steel is used throughout the machine with EPDM, PTFE or other FDA approved gaskets (21CFR part 177).

All models features sloped base and rounded corners to ensure complete drainage. Extensive documentation is provided for the orbital welding.



Heaters

The heater is made to a special design to ensures self cleaning and avoid water stagnation points.



Filters

Air filtering system with HEPA, ULPA filters available option; DOP test connections and filter status check with pressure system.



Easy maintenance

Fully accessible operating area

The machine is developed taking into consideration access of technicians to the maintenance and service area.

Easy access to all components, conforming to safety regulations.



Upper level can be walked on and is designed for easy maintenance access



“Large object washed to pharmaceutical standard”

Construction features

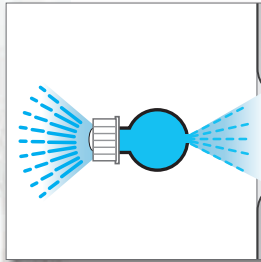

Free draining surface

Extremely accurate project design for the elimination of water stagnation points, surface slopes and complete washing of the whole chamber interior.

Detail thoroughness

Each small cavity is reached. The complete washing of inlet connections for chemical products is assured with special dedicated nozzles.

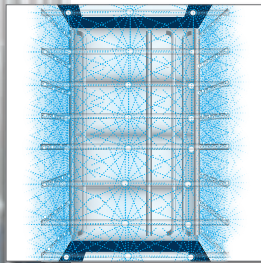

Self cleaning chamber

Self cleaning chamber with nozzles positioned at critical points and sloped surfaces to ensure that no residual water is left.

Cleaning nozzles

Washing nozzles easy to disassemble for periodic maintenance.



Cleaning and inspection

Strong and easily removable grid: enables easy access for cleaning and inspection as well as a rigid stable surface to walk on.

Globally available components

Globally available components, e.g. Gemu, Bürkert, Itt process valves, are standard. Melted or forged, welded on pipe or fixed by clamps (other fittings on request).



Control system for chemical dosing with protection of components





Pharma carts and trolleys

Standard and customized solutions

Steelco's experienced engineers using sophisticated design software ensure that each point, corner and cavity of the item to be processed is deeply and accurately washed.

This eliminates the possibility of cross-contamination and the deposition of residues from previous cycles.

The same injection ports can be used also to direct hot sterile filtered air inside each cavity for drying.

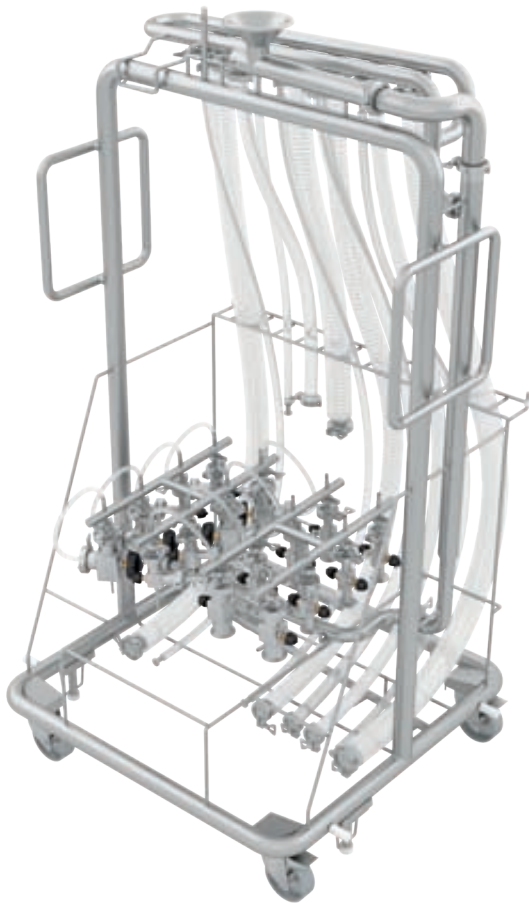

Customized trolley solutions

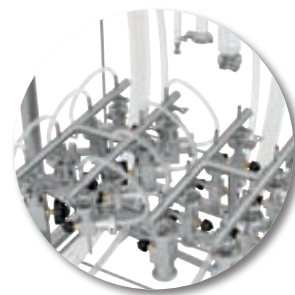

Easy cart connection

Examples of customized accessories for cart connection. Machines can be equipped with special cart connections for water injection. Manual or automatic versions are available.

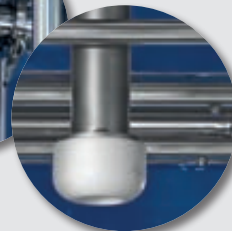

Flexible cart configuration

Changing the dedicated insert/support the same wash cart can be used for different loads.

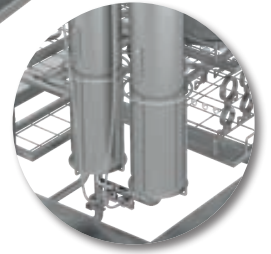
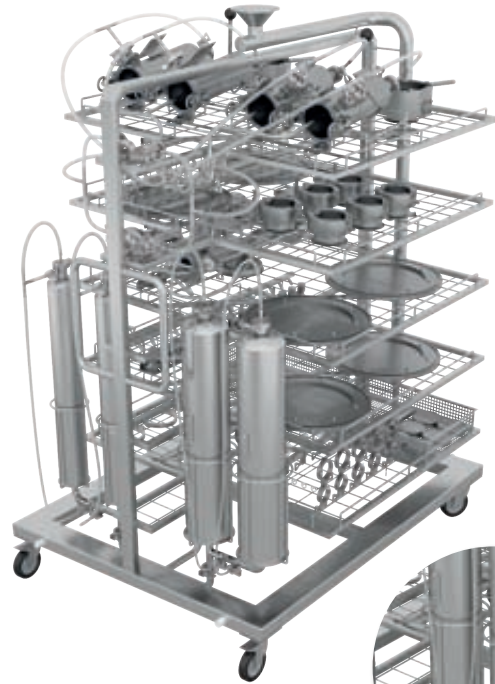

Specific solutions for the most challenging requests

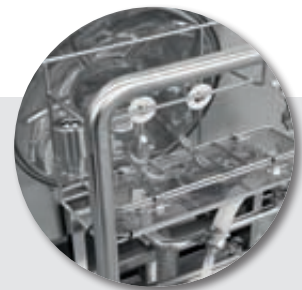
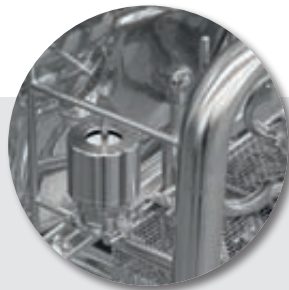



Steelco LB Series Bin Washer Solution



The Steelco LB Series is a system specifically designed for the cleaning and drying of containers and drums in pharmaceutical validated processes.

Custom made for individual customer needs, these units feature the possibility to rotate both the container being cleaned and/or the spray nozzle arm 360° inside the object ensuring exceptional cleaning of all surfaces of the container.

Field of application

Bins, drums, tanks, IBV, IBC

Mixed loads

The chamber can be configured for mixed loads.



Chamber volume

**from 5.000 litres / 177 cu.ft
to 10.000 litres / 353 cu.ft**

in several different dimensions
with configurable options

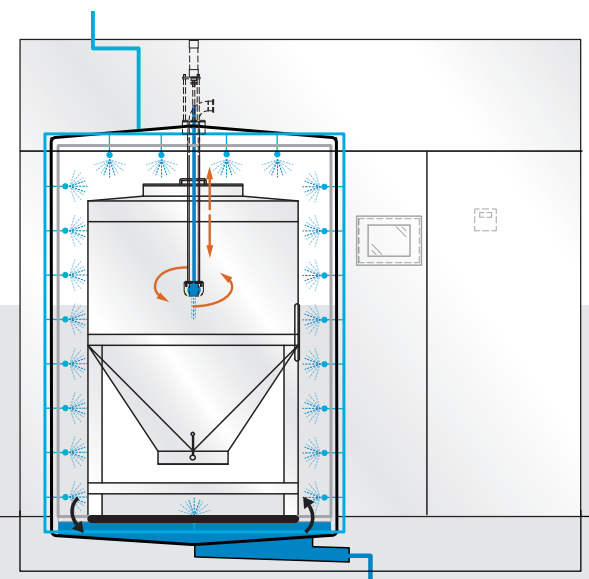

- ✓ *Highest cleaning performance*
- ✓ *360° continuous bin rotating during operation*
- ✓ *Continuous moving top spray arms*
- ✓ *Drying unit with 1000 m³/hour capacity*

Steelco DS PL Series

Industrial challenging application washers

Steelco designs dedicated equipment for industrial demand, including petrochemicals, cosmetic and nutraceutical fields. Effectiveness, safety and high productivity equipment range.



DS 500 PL

DS 800 PL

DS 1000 PL

DS 2000 PL

...

DS 4000 PL

Steelco Sterilizers Series

for life science and pharmaceutical production

Steelco offers an extensive range of steam sterilizing autoclaves for any size facility.



Closure Processor



Steam Air Mixture Sterilizer



Superheated Water Sterilizer



Saturated Steam Sterilizer

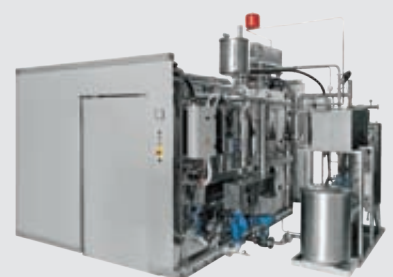

Hot Air Oven

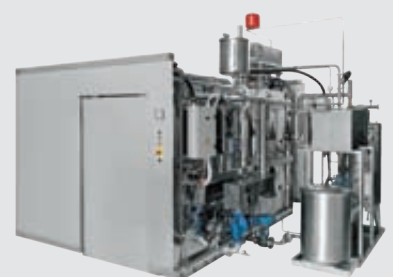

Ethylene Oxide Sterilizer

Sterilization solutions
Serving the pharma industry worldwide



Steelco DS PL range
Industrial challenging application washers



Washers, disinfectors and
automated systems
for animal cages, feeding
bottles and fish tanks

Steam sterilizers VS L series
for pharma and research laboratories



Laboratory glassware
washing systems



Headquarters and
Center of washing systems production

STEELCO S.p.A.

Via Balegante, 27
31039 Riese Pio X (TV) - Italy
Ph. +39 0423 7561 - Fax +39 0423 755528
steelco@steelcospa.com
www.steelcospa.com

Center of sterilizers production

ICOS PHARMA S.p.A.

Via E. Ellero, 15
33080 Cusano di Zoppola (PN) - Italy
Ph. +39 0434 5772911 - Fax +39 0434 5772900
sales@icospharma.com
www.icospharma.com

Branches

STEELCO SPAIN

Madrid, Spain
steelco-spain@steelcospa.com

STEELCO FRANCE

Paris, France
steelco-france@steelcospa.com

STEELCO BENELUX

Vianen, The Netherlands
steelco-benelux@steelcospa.com

STEELCO DENMARK

Kgs. Lyngby, Denmark
steelco-denmark@steelcospa.com

STEELCO GERMANY (DACH Area)

Gütersloh, Germany
steelco-germany@steelcospa.com

STEELCO HUNGARY

Budapest, Hungary
steelco-hungary@steelcospa.com

STEELCO INDIA

Gurugram, India
steelco-india@steelcospa.com

STEELCO ASIA

Puchong, Malaysia
steelco-asia@steelcospa.com

STEELCO USA

West Palm Beach, USA
steelco-usa@steelcospa.com

STEELCO MEXICO

CDMX, Mexico
steelco-mexico@steelcospa.com

Worldwide agencies available for sales support.

